

These probes are designed for measuring low turbidity values according to nephelometric method and they are ISO 7027 - EN 27027 compliant.

TU 8325 probe is for submersible installation.

TU 8525 probe is for overflow and in-line installation.

Thanks to the analog and digital outputs, the probes can be connected to the most common PLC's or data acquisition boards.

B&C Electronics offers MC 6587 and MC 7687 multi-channel controllers that allow complete management of up to three probes, displaying the measurements and the messages that guide calibration and configuration.

Main features

Ranges

The probes can be configured in range from 4 NTU to 400 NTU. It is also possible to associate a scalability factor from 10% to 100% to obtain intermediate full-scale values on the 4/20 mA current loop through digital commands.

Operating mode

The probes can be configured to operate in analog or digital mode. If connected to a master device it is possible to carry out several operations through specific digital commands

Analog output

The 4/20 mA current loop is proportional to the main measurement value. The current loop is galvanically isolated, for direct connection to PLC or data acquisition boards.

Serial interface

The RS485 isolated serial interface allows for calibration and configuration of the probes, the simultaneous transmission of turbidity measurements, check signal and average value of ambient light and temperature. The boot loader function allows the user to update the probe's firmware.

Communication protocols

The B&C ASCII protocol coexists with the MODBUS RTU protocol (03, 06, 16 function) for the transmission of the measurements, the configuration and calibration of the probe.

Filter software

A filter software operates on the sensor input signal with two selectable time constants. In order to obtain good reading stability and fast response to the changes in the process, the user can set the response time for both the small or large variation signals.

Self-diagnostic

The "check signal" is a unique feature that provides a continuous verification of the status of the optical lens and the potential absence of sample in the measuring cell or in the tank.

A dedicated alarm can be configured to alert the user in case of potential malfunctions.



TU 8325



TU 8525

Autocleaning

TU 8325 model is equipped with an automatic cleaning device. A blast of pressured air is sent onto the sensing elements keeping them clean from deposits of organic substances.

Zero stability

Thanks to a pulsed light source, then sensor performs an automatic zero at every measuring cycle. This unique feature guarantees for accuracy and stability in samples with near-zero turbidity.

Temperature compensation

The probes include a temperature sensor for internal compensation of optical efficiency.

Power supply

The probes are powered with 9/36Vdc voltage on the current loop, supplied by a PLC or data acquisition boards or by a power supply placed in series between the analog output and the acquisition device. Even in digital mode the power is supplied by the current loop.

Dry standard

An accessory is available to check the right functioning and calibration of the probes installed in the process without the need of formazin turbidity standard. If allowed by the plant's calibration protocol, the dry standard can be used to calibrate TU 8525.

Measuring method

The turbidity measurement is carried out with the method of light diffusion caused by the suspended particles in the sample. A light beam of a given wavelength is sent into the sample through a transparent lens. The portion of light diffused at an angle of 90° by the suspended particles in the sample returns to the probe through a second optical lens. Then it is detected by the internal circuits and converted into an electrical signal proportional to the sample turbidity. The infrared light source makes the measurement independent from the sample color.



Technical specifications

Turbidity ranges:	0/4.000 – 0/40.00 – 0/400.0 NTU
Scalability factor 4/20 mA:	10/100 %
Sensitivity:	70/130 %
Zero:	± 0.400 NTU
Resolution:	0.001 NTU
Accuracy:	0.2 % of the full-scale selected
Repeatability:	0.1 %
Non-linearity:	0.1 %
Check signal:	0/200.0 %
Temperature limit:	0/50 °C
Dual filter software:	2/220 seconds
Power supply:	9/36Vdc
Current loop:	4/20 mA isolated
Load:	600 Ohm max. at 24Vdc
Digital output:	RS 485 isolated
Protocols:	B&C ASCII and Modbus RTU (03, 06, 16 functions)
Baud rate:	2400 / 4800 / 9600 / 19200 baud
Probes ID:	01/99 (B&C protocol) 01/243 (Modbus protocol)
Probes network:	32 max.
Operating temperature:	60 °C max.
Operating pressure:	6 bar at 25 °C (TU 8525) 1 bar at 25 °C (TU 8325)
TU 8525 dimensions:	L=143 mm, D=40 mm
TU 8325 dimensions:	L=165 mm, D=60 mm
TU 8525 weight:	Body 160 g, cable 640 g
TU 8325 weight:	Body 420 g, cable 640 g
Body:	PVC-C (TU 8525.5 model in PVDF is available)
Cable:	10 m (100 m max.), PVC sheath
Protection:	IP 68
EMC/RFI conformity:	EN 61326-2-3/2013, EN 55011/2009

The technical specifications could be changed without notice.

Overflow installation



TU 910

TU 8525 probe can be installed in overflow with the overflow cells **TU 910** or **TU 920**.

TU 910, more suitable for low turbidity values, is equipped with a small valve to regulate the flow in the cell and to keep the liquid under pressure. The valve also works as a degasser to remove air bubbles in the sample.

TU 920 cell has larger inlet and outlet fittings and it is more suitable for high turbidity values. This cell does not have a valve for flow adjustment.

Both models are supplied with a wall mounting bracket.



TU 920

Technical specifications

Sample flow	0.2 ÷ 0.5 l/min
Operating Temperature	0 ÷ 50 °C
Sample temperature	0 ÷ 50 °C
Sample pressure	max 6 bar a 20 °C
Body material	PVC
Seals material	NBR
Valve material	POM (TU 910)
Fittings	1/8" for 4x6 mm pipe (TU 910) 1/8" for 6x8 mm pipe (TU 920)

In-line installation



YAT75M0021

TU 8525 probe can be mounted in a pipeline directly with a flow Tee adapter.

YAT75M0021 (with 1892702 adapter + 2713118 O-Ring) guarantees perfect installation and maintenance safety. This fitting is glue type and must be installed to the bypass pipe having an outer diameter of 2".

This type of installation is recommended for values above 40 NTU, and in any case in samples without air bubbles.

Submersible installation

Both probes can be installed in a tank.

B&C Electronics offers a series of accessories that guarantee the correct inclination of the probe and the protection of the cable and connector from organic deposits.

SZ 7521 Adapter for TU 8525. It can be glued to an extension pipe having DN20 or DN32.

0012.450043 Adapter for TU 8325. It requires an extension pipe with 1" FNPT thread.

0012.000624 Swivel mount to fix the probe to a standard handrail on the side of the tank. The supply includes 0012.450043

0012.440040 Hose for automatic air injection. Can be used with TU 8325 only.



Typical installation of the probes with adapter and extension pipe.

Dry standard



The regular operation and calibration of the turbidimeters is carried out normally through the use of formazin turbidity standards (ISO 7027 or EPA 180.1) which, in addition to being very expensive, have a short life time and some practical difficulty in the use on the plants, both in the preparation and in the storage. This rises the needs for operators to be able to make a simple and convenient control of the turbidity system or, where permitted, a calibration without using of formazin or equivalent standards, simulating the values of turbidity using a dry device.

TU 9632 consists of a cylinder in which to insert the TU 8525 probe, at the bottom of which is housed a dry optical element suitable to produce a controlled light diffusion that simulates the turbidity of a liquid at value lower than 20 NTU.

PC connection

Customers that use the probes in analog mode can also take advantage of the functions available through the digital mode. B&C Electronics offers BC 8701 a RS485/USB converter to connect the probes to a PC. An easy-to-use software, supplied on demand and free of charge, guides the user through configuration and calibration operations.

TU 8355 dimensions

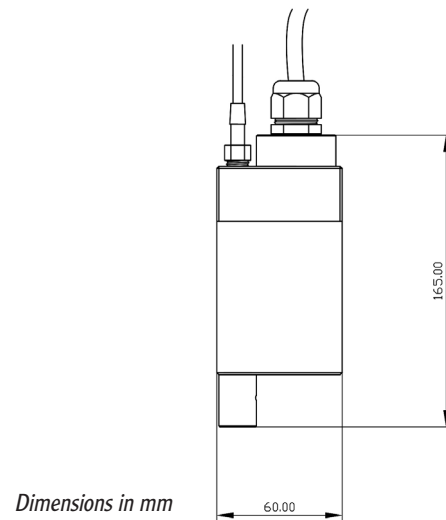

TU 8555 dimensions

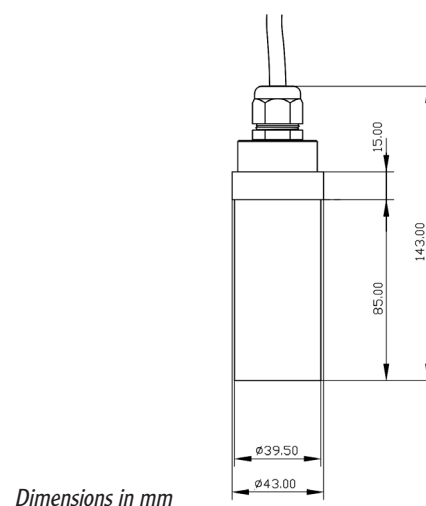

Applications

- Drinking water
- Aquaculture
- Food and Beverage
- Pulp and Paper
- Chemical Industry
- Pharmaceutical Industry
- Electroplating
- Printing Industry
- Textile Industry
- Fertirrigation
- Swimming pools
- Waste Water Treatment
- Surfaces Treatment